

fördern: Faszination Energie



**OST**  
Ostschweizer  
Fachhochschule

**IES** | Institut für  
Energiesysteme

# Wir machen Dampf - Jetzt gibt's Hochtemperaturwärmepumpen

Leon Brendel PhD

Dr. Cordin Arpagaus

Frederic Bless, PhD

Prof. Daniel Gstöhl,

Prof. Stefan Bertsch

**30. März 2026**



# Aktueller Stand 3D Visualisierung CO2-neutrale Energieversorgung

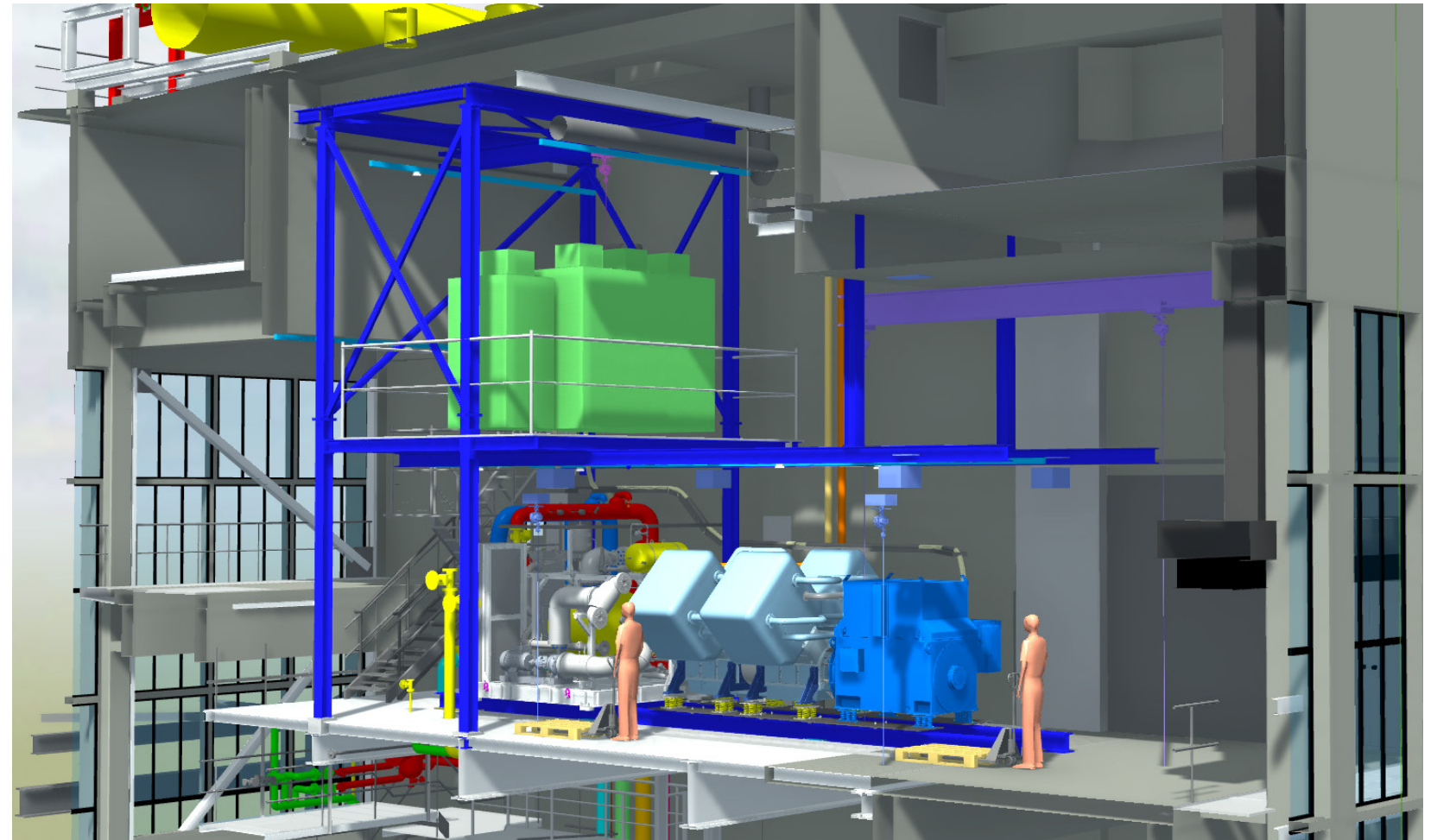

# Aktueller Stand der Erschliessung



**30%**

des Siedlungsgebietes ist heute mit Fernwärme erschlossen



**60%**

des Siedlungsgebietes soll bis 2040 erschlossen sein



**2'260'000'000**

Über 2 Milliarden Franken Investitionen werden für das Generationenprojekt benötigt

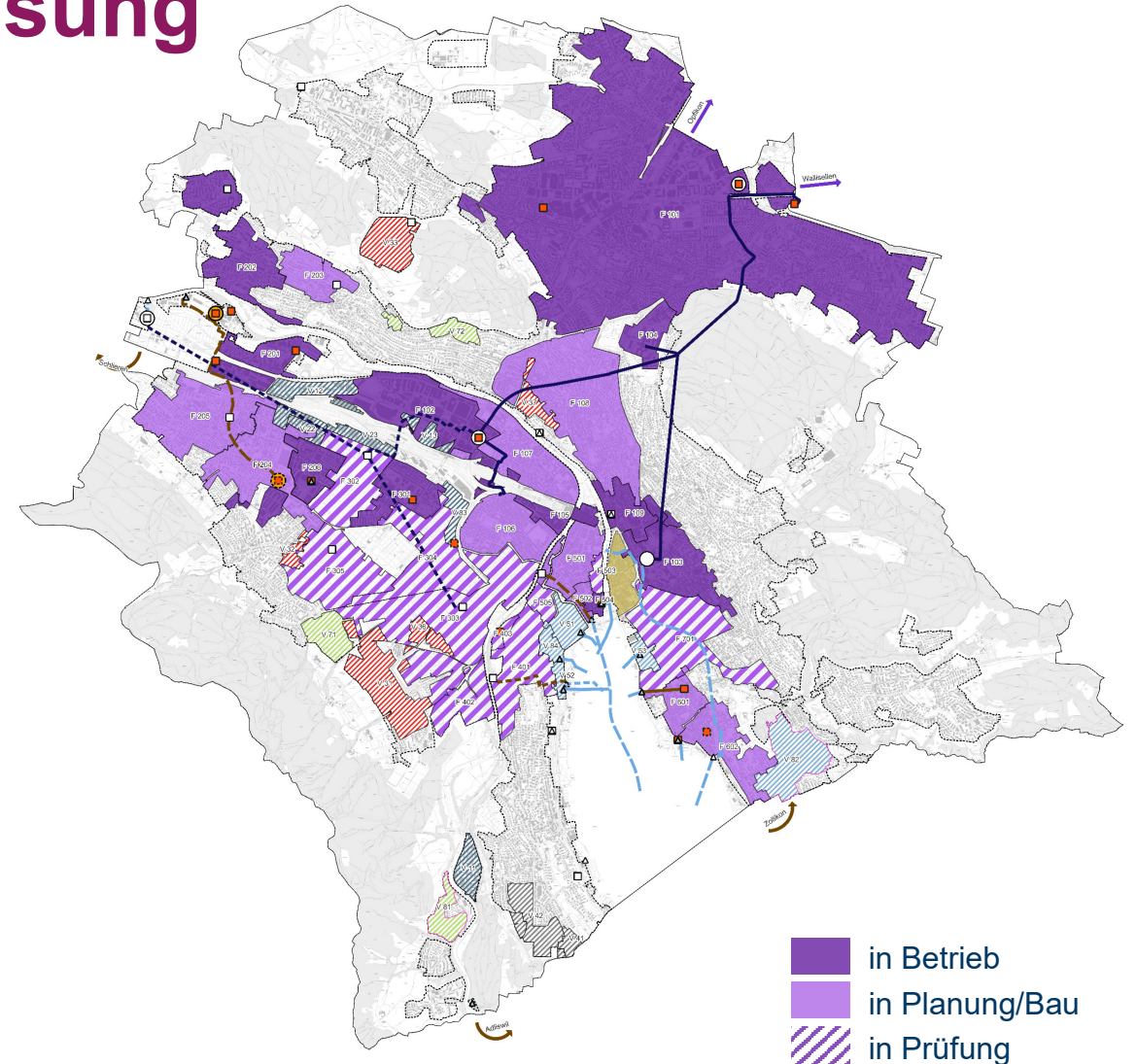

# Energieträgermix- & Bedarfsentwicklung

## Gesamtgebiet

Folie von Pascal Leumann - EWZ



### Ausbau Abwärme

Verdopplung auf ~1000 GWh/a



### Ausbau Umweltwärme

**Schlüsseltechnologie Wärmepumpe**  
Benötigte Leistung ~ 300 MW  
mit natürlichen Kältemitteln



Holzenergie in die Spitzenlast, anstatt Grundlast  
Effizienzsteigerung durch Wärmerückgewinnung



### Flüssige & gasförmige Brennstoffe

Reduktion fossiler Energie von heute 30%  
auf rund 10% bis 2030 und 5% bis 2035

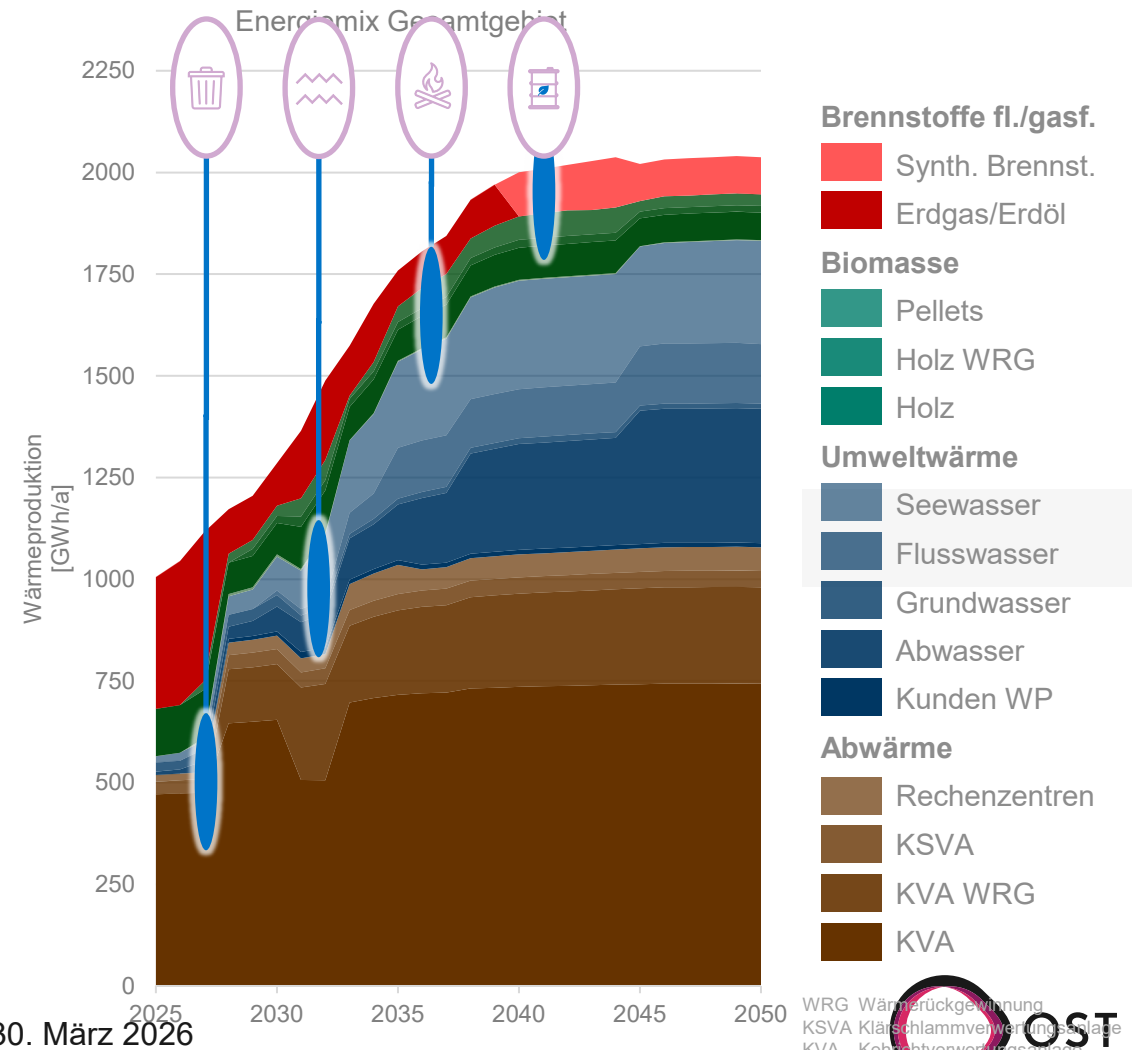

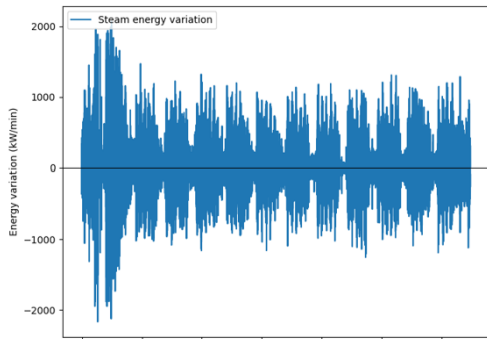
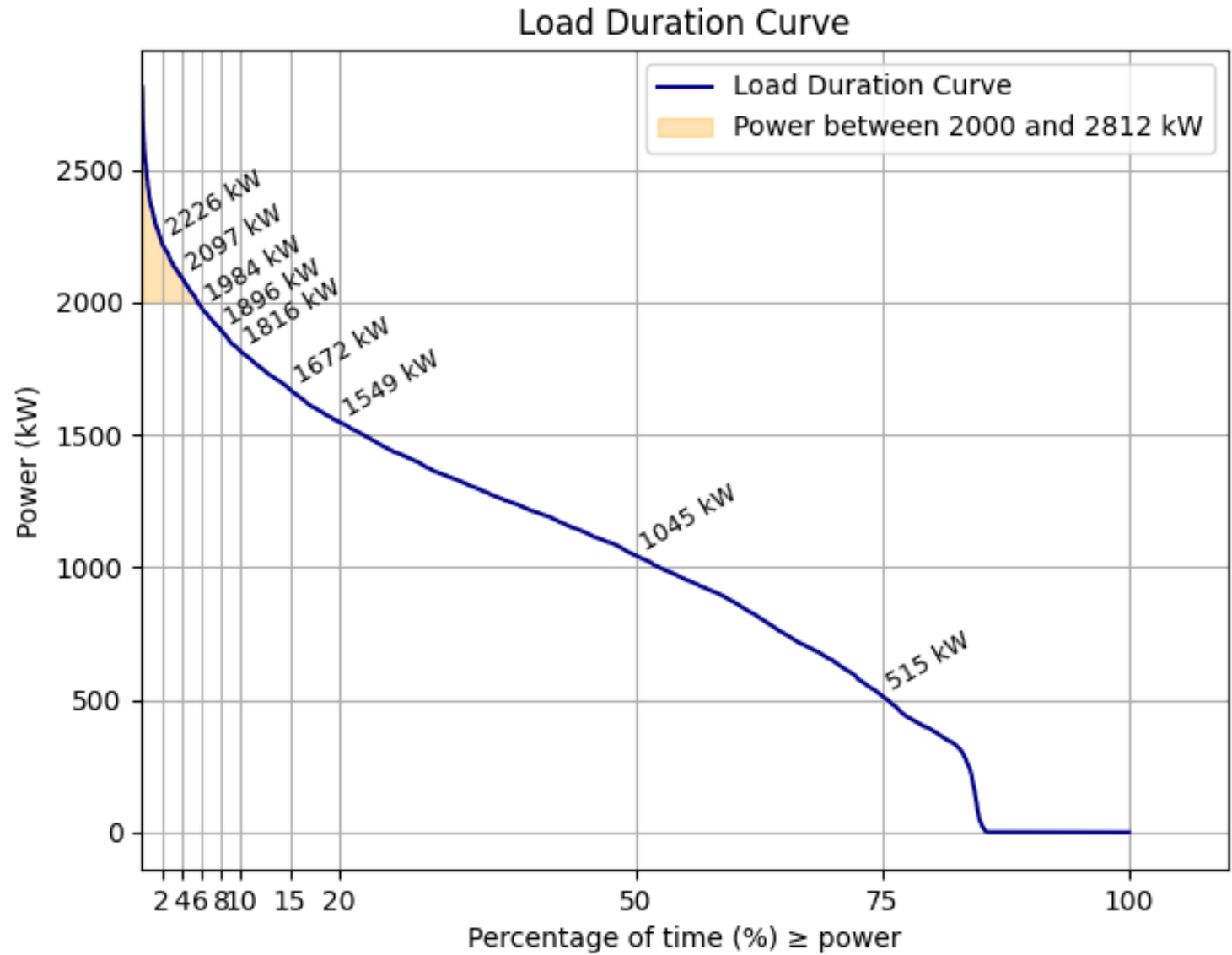

Wie es überhaupt dazu kam

OSTSCHWEIZER FACHHOCHSCHULE



# Was gibt es schon alles und wie baut man es ein?



(Liste ist nicht abschliessend)

# Marktentwicklung

2024

50 HTWPs > 100 °C

2018

25 HTWPs > 90 °C

Verdichter Typ: Schraube Kolben Turbo Andere

Kältemittel

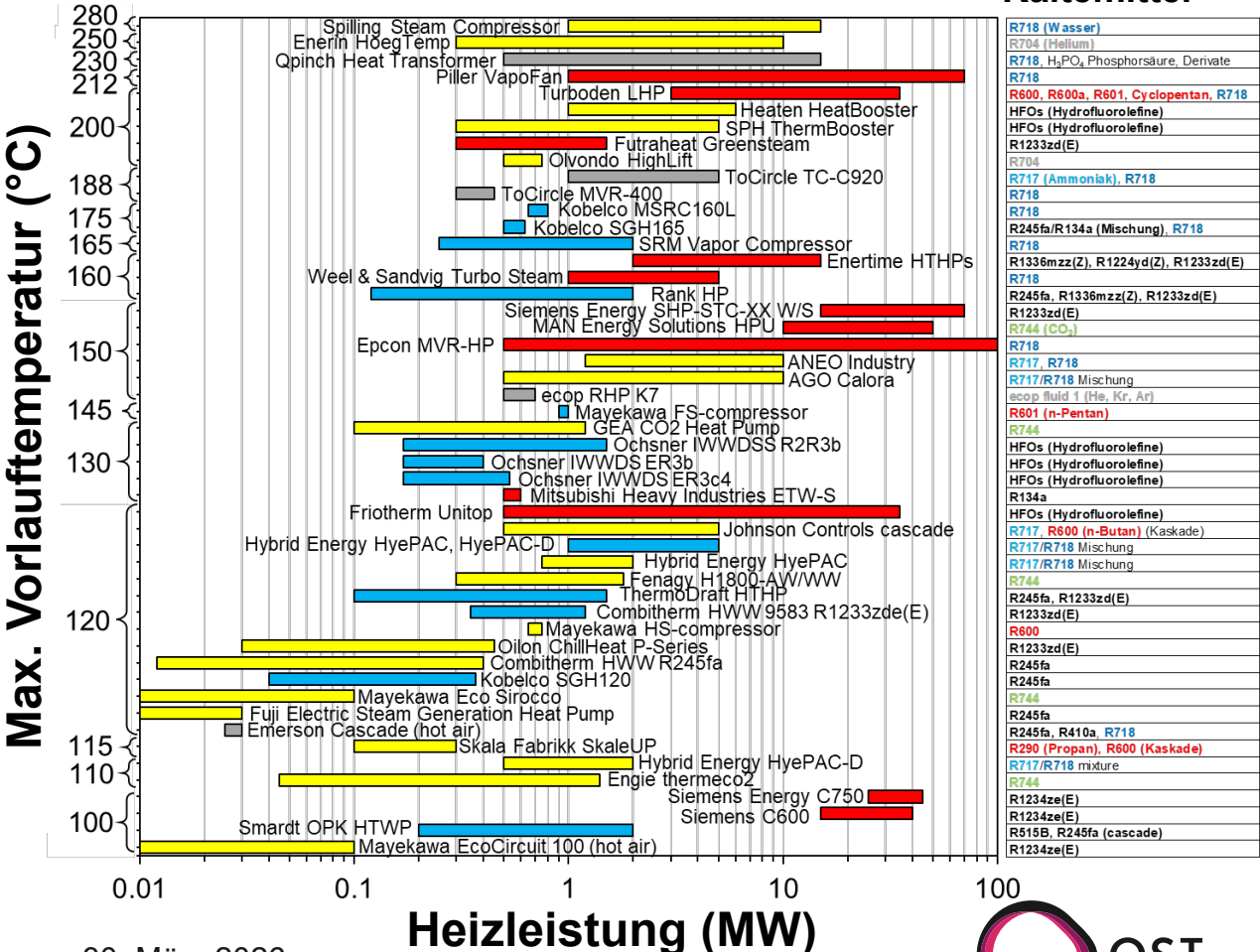
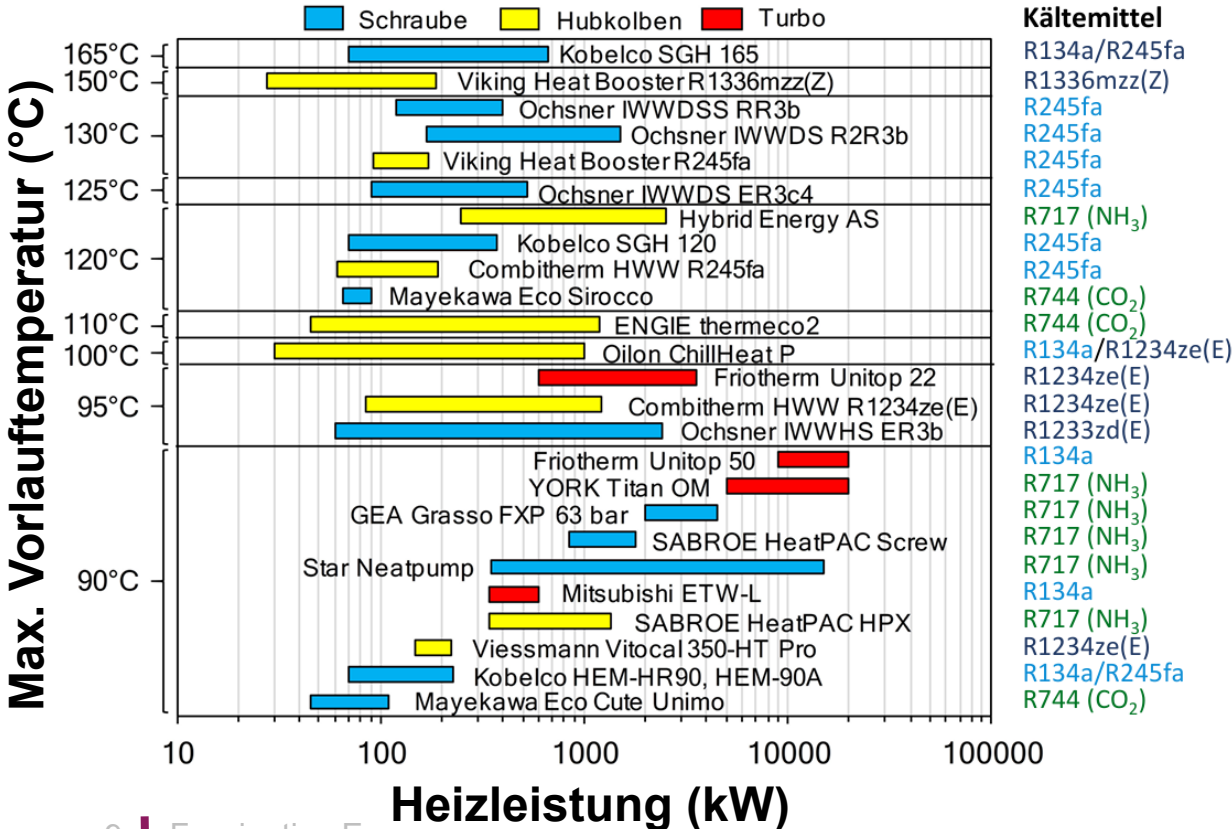

Verdichter Typ: Schraube Kolben Turbo Andere

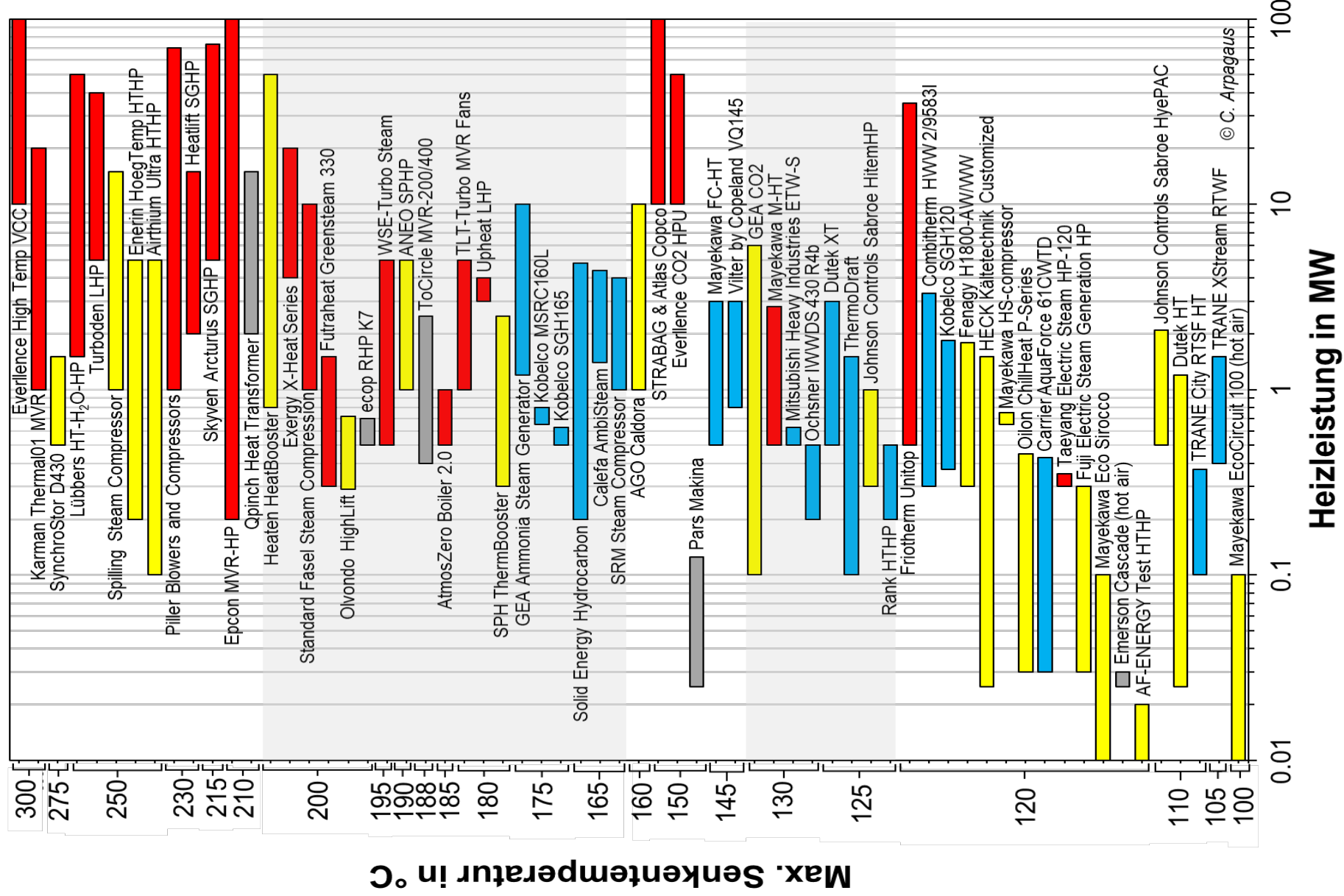

© C. Arpagaus



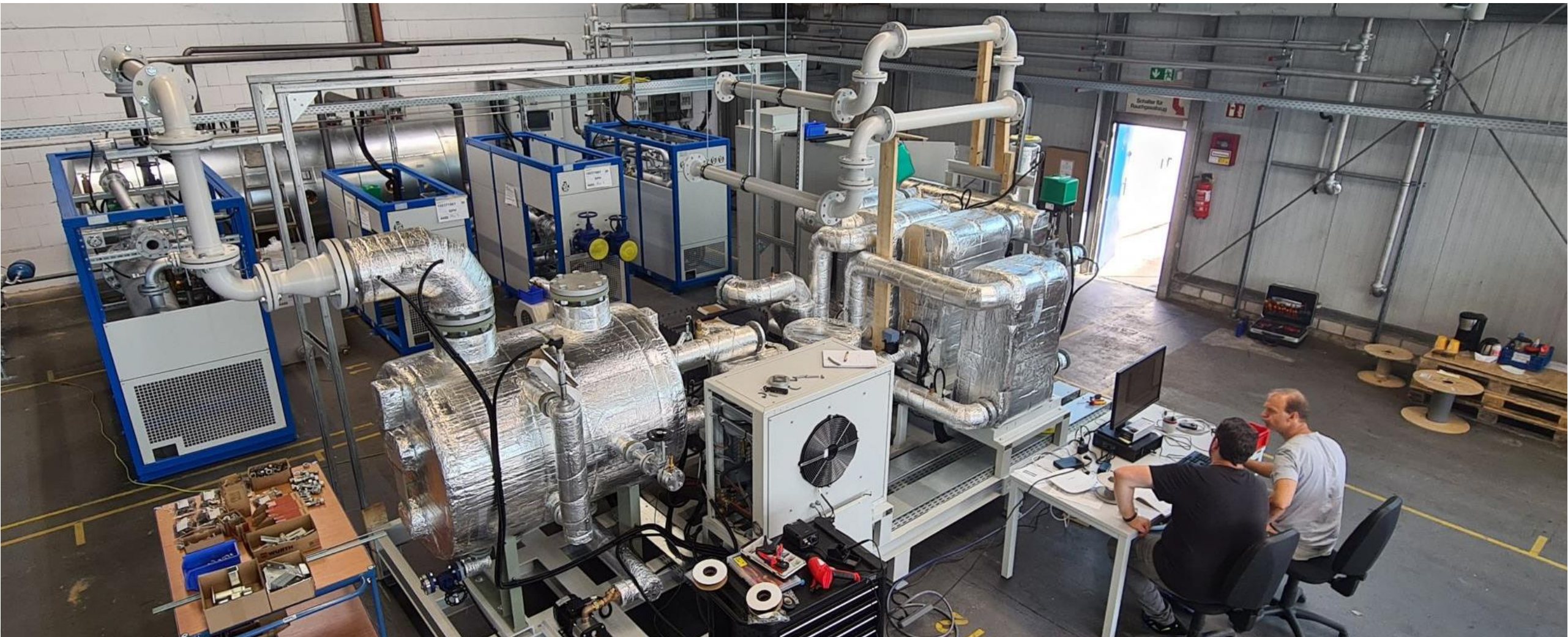

# CO<sub>2</sub> Wärmepumpe für Heisswasser Produktion

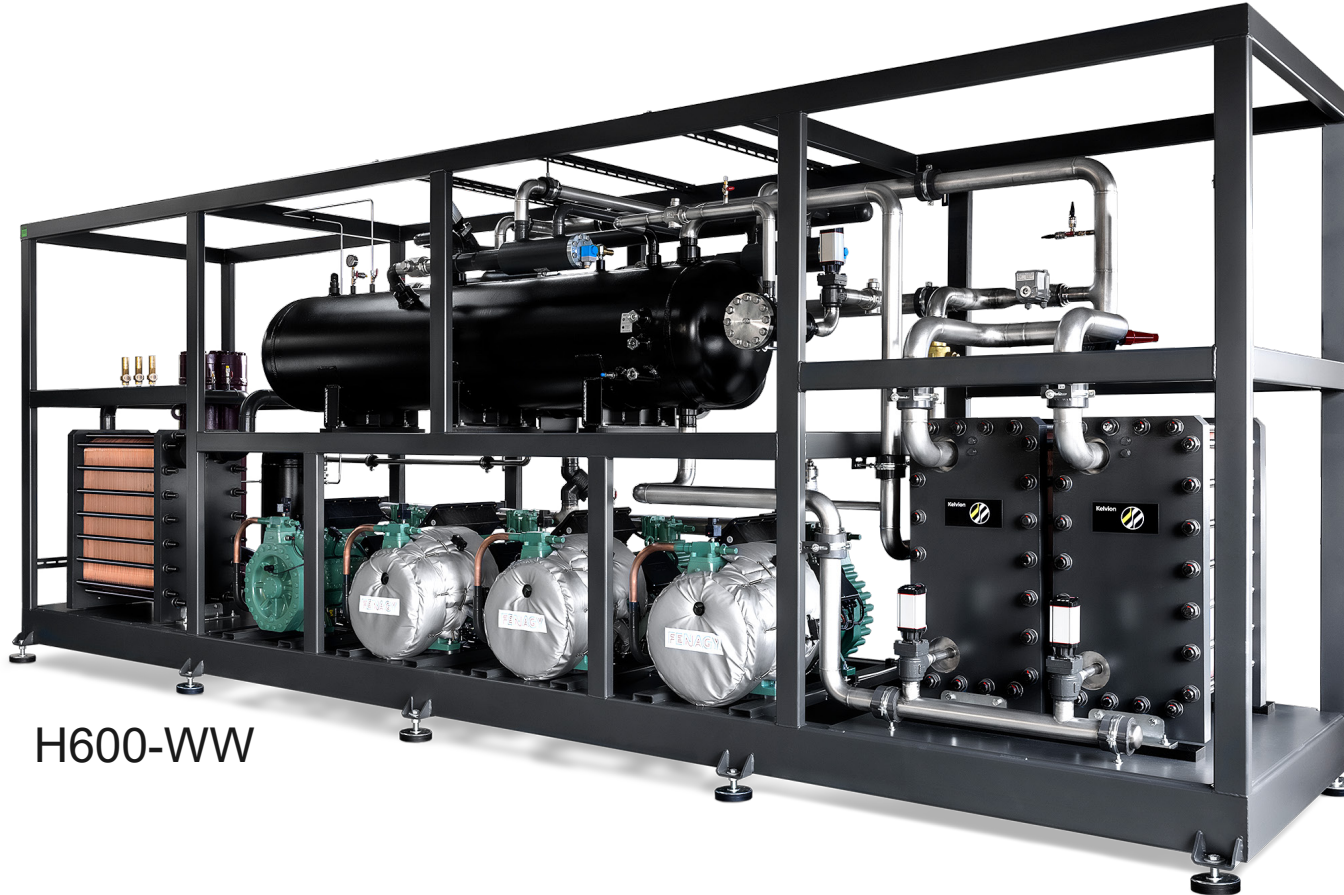

H600-WW

- Heizleistung von 0,3 bis 1,8 MW
- Warmwassererwärmung von 30 bis 120 °C
- Wärmequelle: Luft (AW) oder Wasser (WW)
- Hubkolbenverdichter (Dorin oder Bitzer)
- Niedrige Vorlauftemperatur der Wärmesenke zur Steigerung der Effizienz im CO<sub>2</sub>-Kreislauf erforderlich

### Estimated performance

T <sub>source,in</sub> [°C]	T <sub>source,out</sub> [°C]	T <sub>sink,in</sub> [°C]	T <sub>sink,out</sub> [°C]	COP <sub>heating</sub> [-]
0	-5	30	120	2,46
0	-5	30	120	2,61*
5	0	30	120	2,63
5	0	30	110	2,91*

\*including expander

# Rotationswärmepumpe von ecop Technologies GmbH

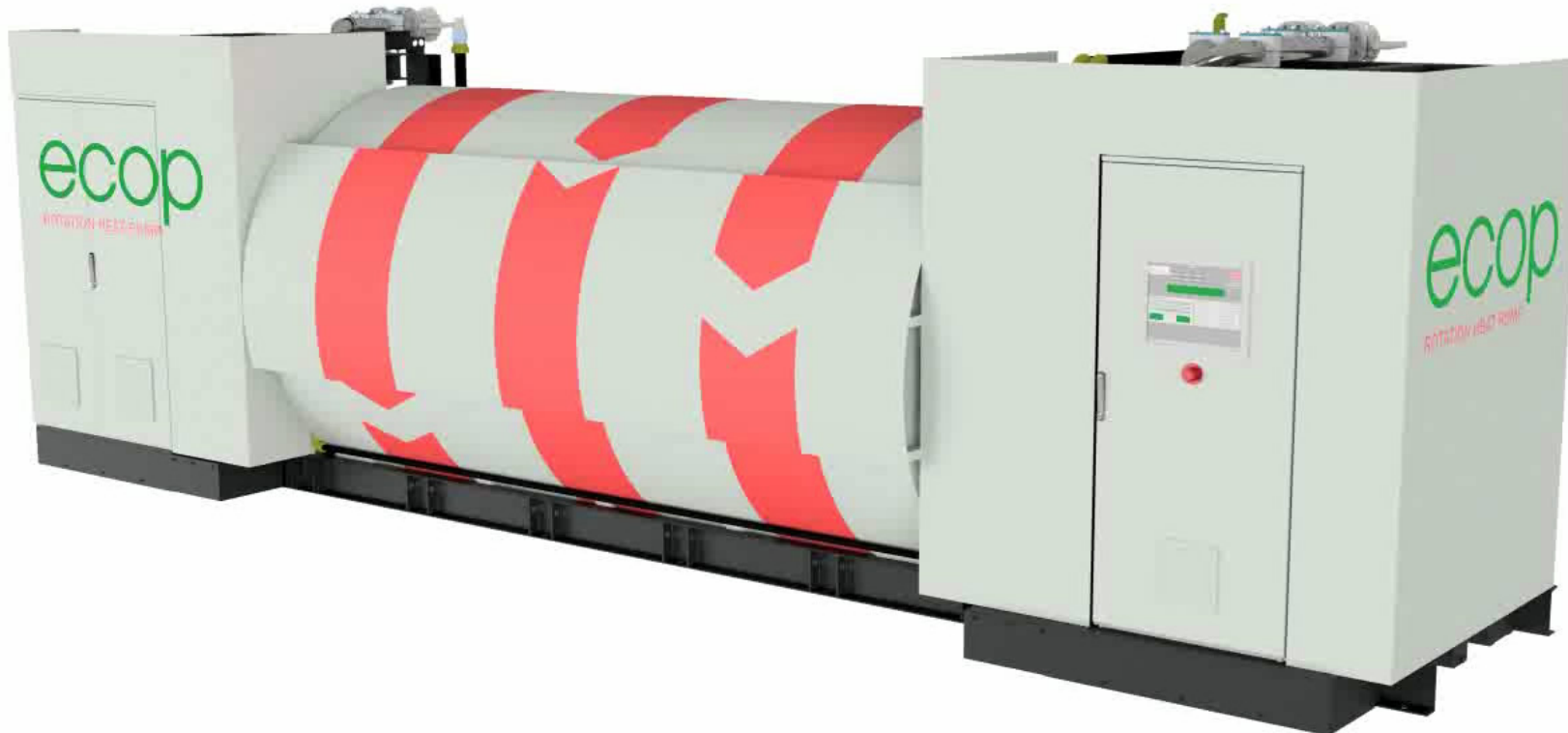

- Joule Prozess
- Arbeitsmedium: Edelgas Gemisch aus Argon, Helium, und Krypton
- $GWP < 1$ ,  $ODP = 0$
- Nicht giftig
- Nicht brennbar
- Kein Thema mit PFAS bzw. TFA
- Heizleistung: 700 kW thermisch (400 bis 800 kW)
- Flexible Temperaturbereiche von  $-20\text{ °C}$  bis  $150\text{ °C}$
- Temperaturspreizung bis 70 K (Quelle aus zu Senke aus)
- [www.ecop.at](http://www.ecop.at)

# Caldora von Ago-Energie



- Absorptions/Kompressionskältekreislauf
- Ammoniak/Wasser als Kältemittel



- Bis etwa 150 °C
- Bis zu 10 MW

# Butan (R600) Wärmepumpe von Mayekawa Europe NV

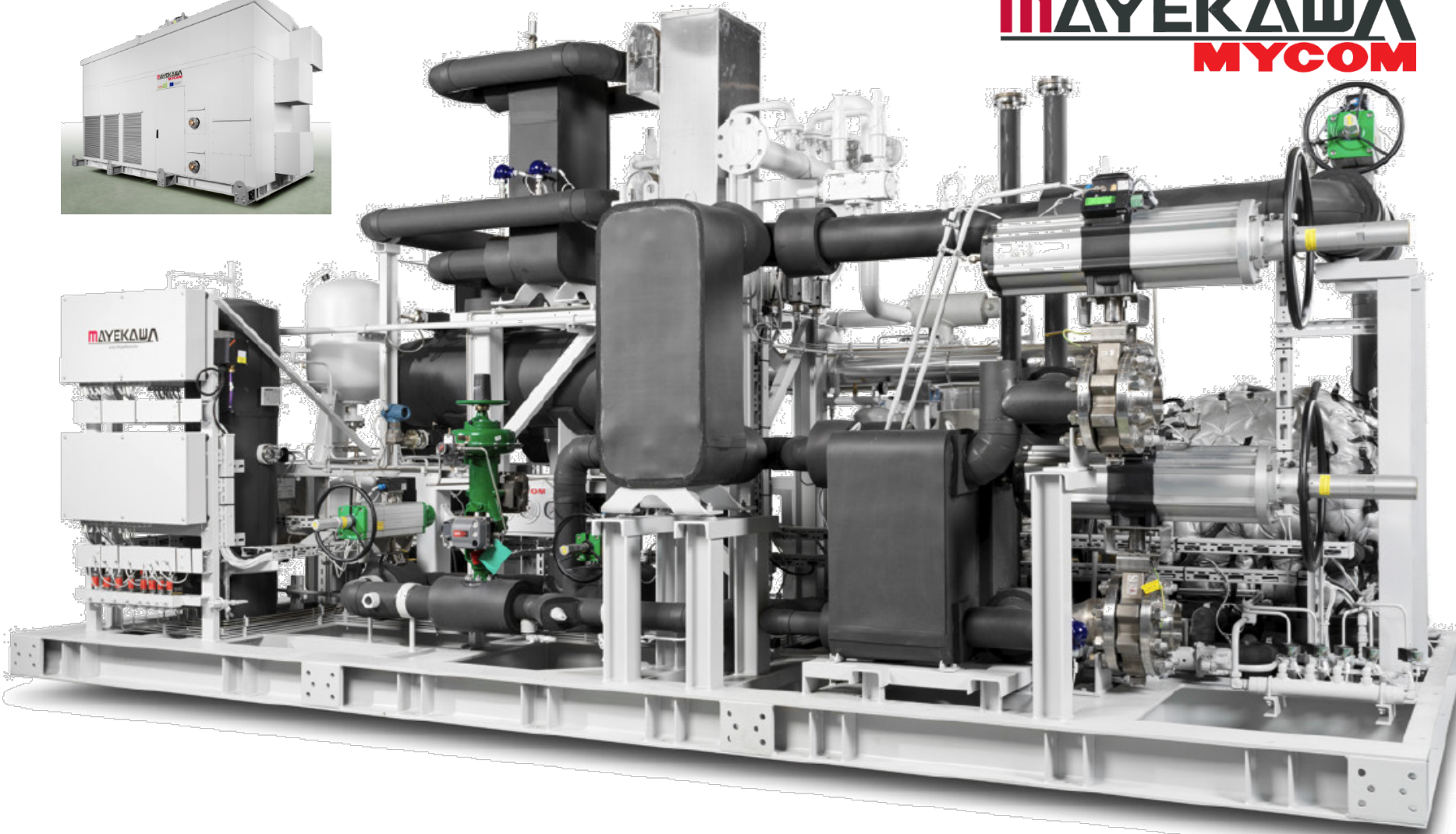

- Heizleistung rund 750 kW
- Hubkolbenkompressor
- 18 m<sup>2</sup> Stellfläche
- Heiße Sole bis zu 120 °C (70 °C Einlass) für Fernwärmeanwendungen
- Wärmequelle: 72 °C (Eingang), 45 bis 65 °C (Ausgang)
- COP 3.2 bis 4.8

T <sub>source,in</sub> [°C]	T <sub>source,out</sub> [°C]	T <sub>sink,in</sub> [°C]	T <sub>sink,out</sub> [°C]	COP <sub>heating</sub> [-]
72	65	70	120	4.8
72	60	70	120	4.4
72	55	70	120	4
72	50	70	120	3.7
72	45	70	120	3.2

# Zentral oder Dezentral

- Häufig verfolgt wird Konzept 1
- Konzept 2 hat gewichtige Vorteile
  - Temperaturoptimierung
  - Schaden im Ausfallsfall
  - Kleine Füllmengen
- **Größenvergleich**
  - 100 kW, 1 MW, 10 MW
- **Vergleiche mit Eigenheim**
  - Kühlschrank
  - Automobilklimaanlage
  - Wärmepumpe
  - Gefriertruhe
  - Warmwasserboiler
  - Wärmepumpenwäschetrockner

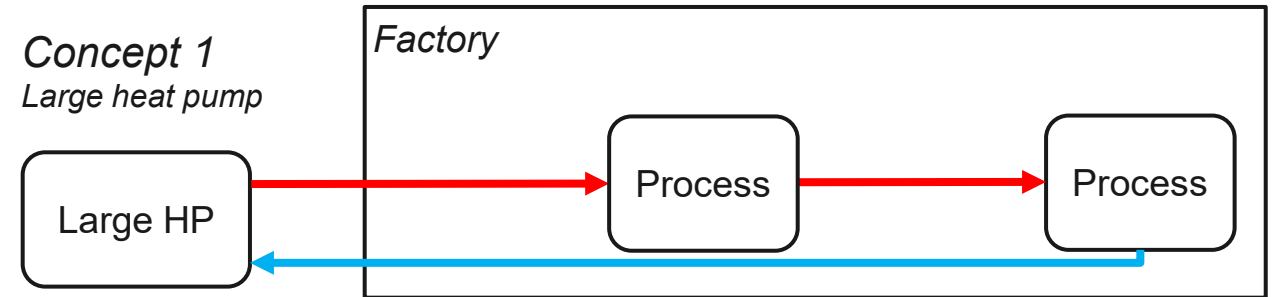



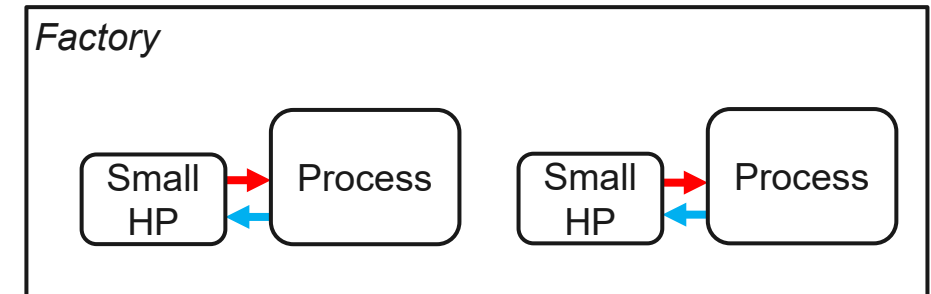



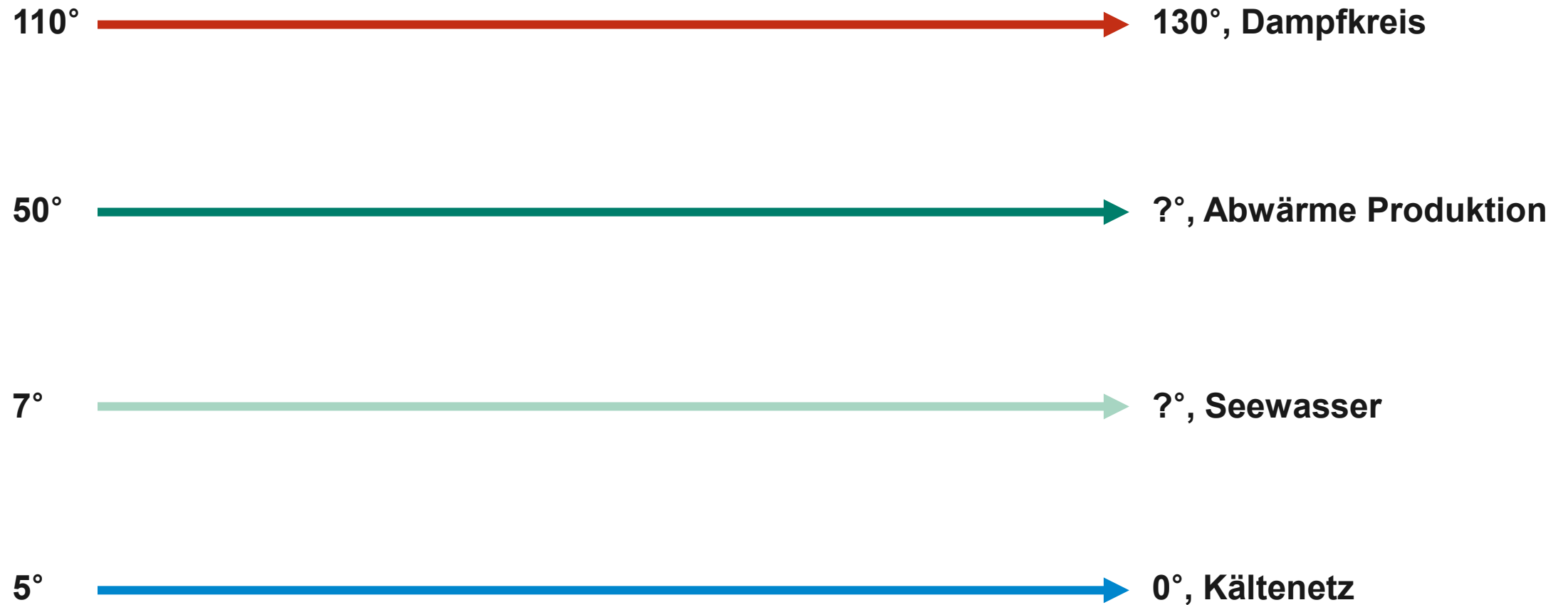





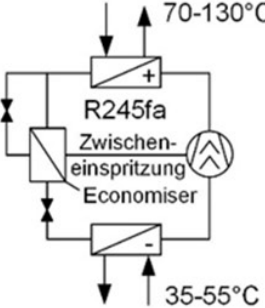

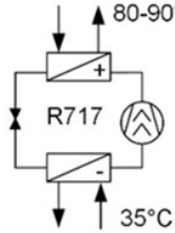

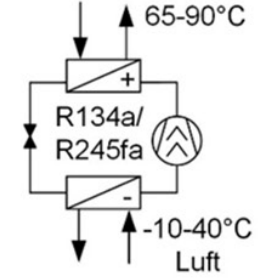

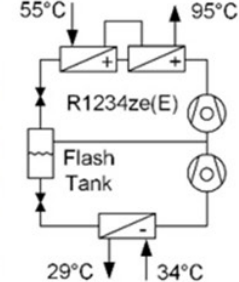
*Concept 2*  
*Distributed heat pumps*

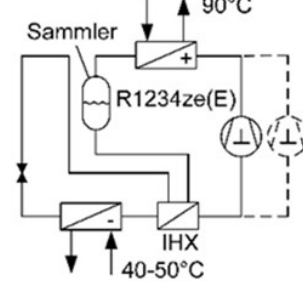

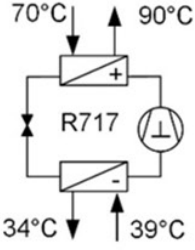
# Beispiel: Integration von Industriewärmepumpen

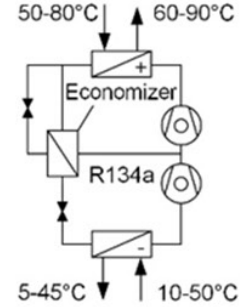

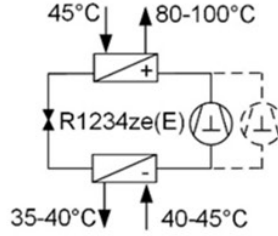
# Auswahl an industriellen HTWP mit Keisläufen

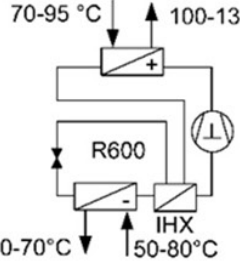
<p> <b>Ochsner IWWDS ER3b</b></p>  <p>70-130°C</p>  <p>R245fa Zwischen-einspritzung Economiser</p> <p>35-55°C</p>	<p> <b>GEA Grasso FX P Heat Pump</b> Doppelschraubenkompressor bis 63 bar</p>  <p>80-90°C</p>  <p>R717</p> <p>35°C</p>	<p> <b>Kobe Steel Kobelco HEM-HR90</b></p>  <p>65-90°C</p>  <p>R134a/ R245fa</p> <p>-10-40°C Luft</p>
<p> <b>Friotherm Unitop 22/22, 3'300 kW, zweistufiger Turbokompressor</b></p>  <p>55°C</p>  <p>R1234ze(E) Flash Tank</p> <p>29°C</p> <p>34°C</p> <p>95°C</p>	<p> <b>Viessmann Vitocal 350-HT Pro</b></p>  <p>90°C</p>  <p>Sammler R1234ze(E) IHX</p> <p>40-50°C</p>	<p> <b>Johnson Controls, SABROE HeatPAC HPX</b> Hubkolbenkompressor bis 60 bar</p>  <p>70°C</p>  <p>R717</p> <p>34°C</p> <p>39°C</p> <p>90°C</p>
<p> <b>Mitsubishi ETW-L</b></p>  <p>50-80°C</p>  <p>Economizer R134a</p> <p>5-45°C</p> <p>10-50°C</p> <p>60-90°C</p>	<p> <b>Oilon ChillHeat P300 SU HC+ R1234ze</b> mit 4 parallel geschalteten Kolbenverdichtern</p>  <p>45°C</p>  <p>R1234ze(E) IHX</p> <p>35-40°C</p> <p>40-45°C</p> <p>80-100°C</p>	<p> <b>Frigopol HighButane 2.0</b></p>  <p>70-95 °C</p>  <p>R600 IHX</p> <p>40-70°C</p> <p>50-80°C</p> <p>100-130°C</p>

# Kreislaufkomplexität im Vergleich mit Supermärkten

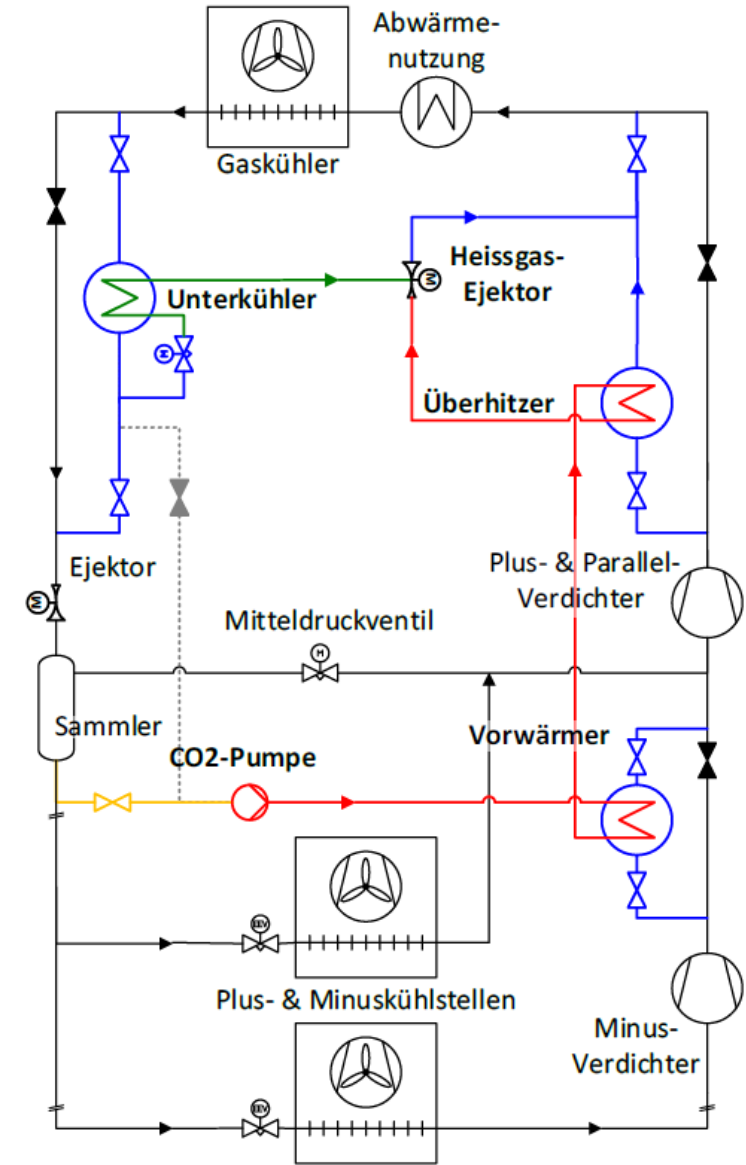
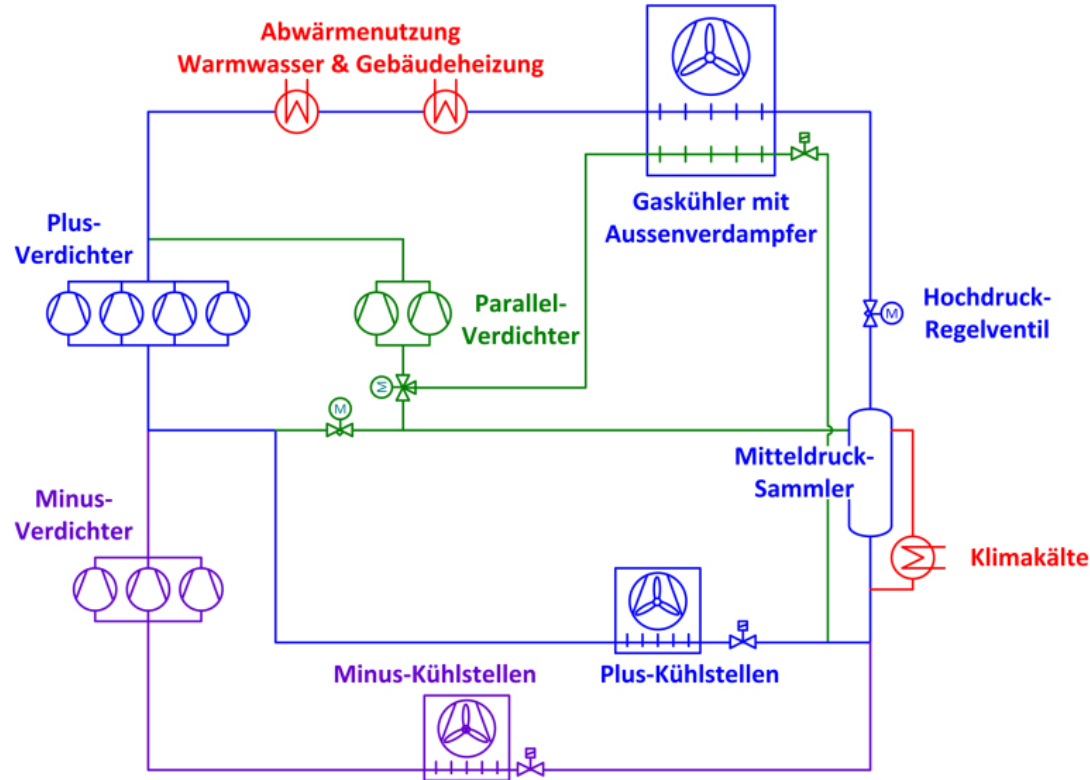

Beispiele von Frigoconsulting

# Ein Paradies für findige Ingenieure

# Beispiel Fernwärmenetzerweiterung

Neuer  
Abnehmer



# COP Abschätzung

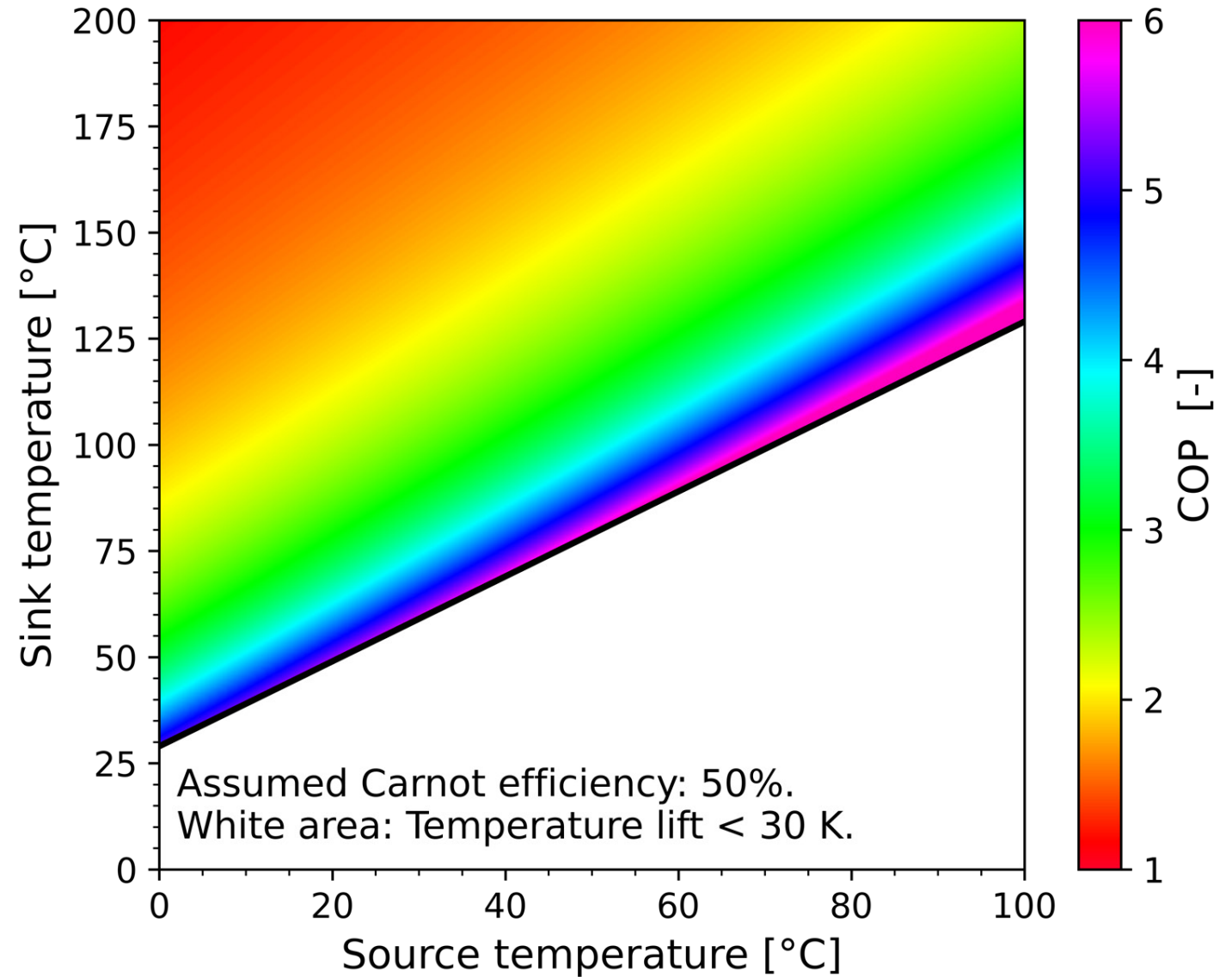
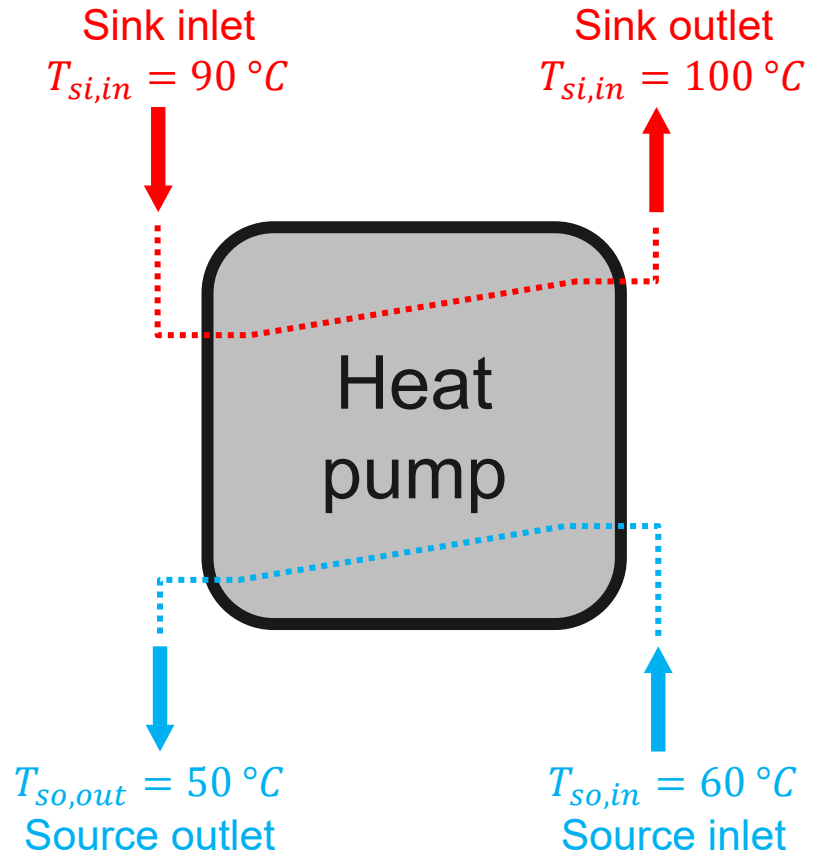

# Dampfproduktion und Nachverdichtung

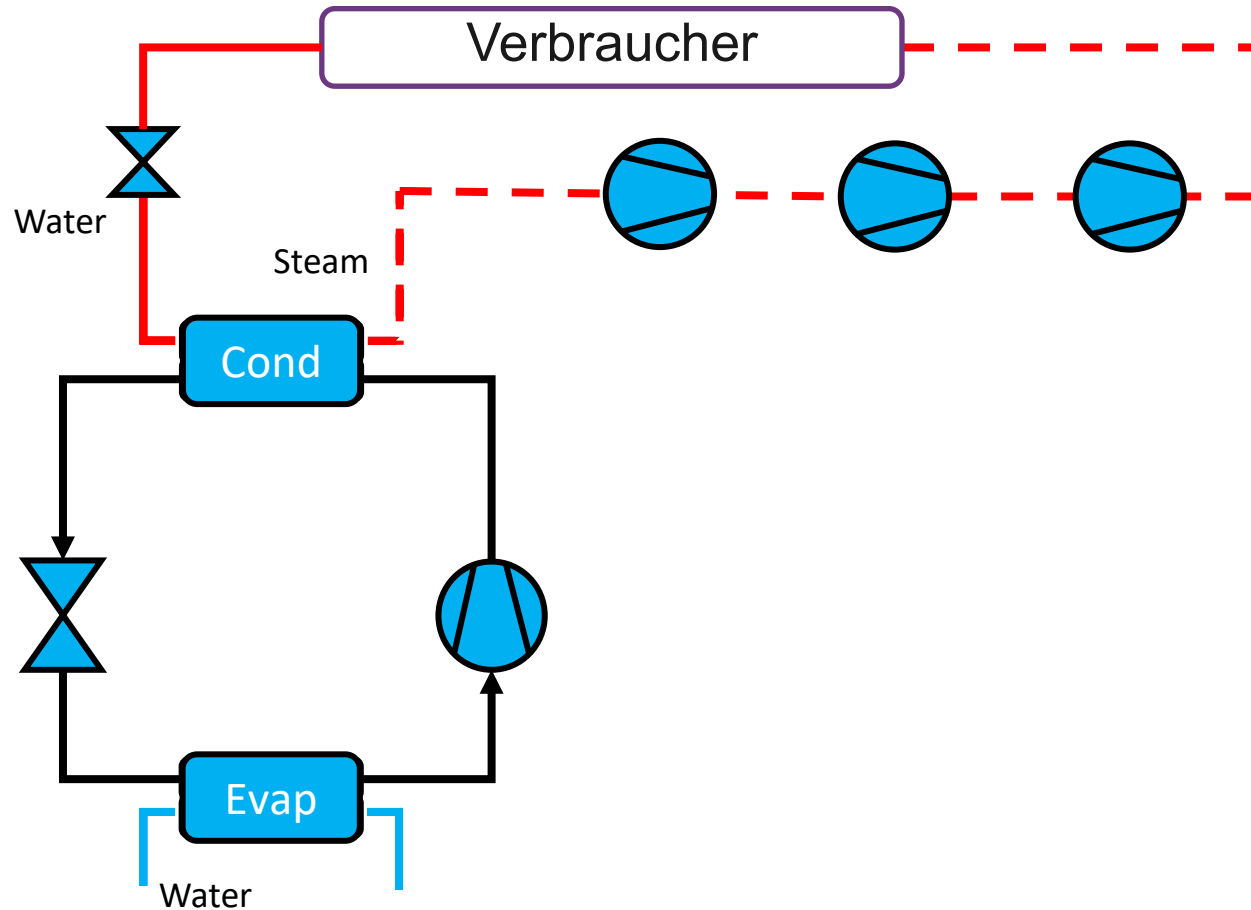

# Dampwärmepumpen

## Übersicht Dampfkompressoren



Integrally geared centrifugal compressor (pict. Howden)

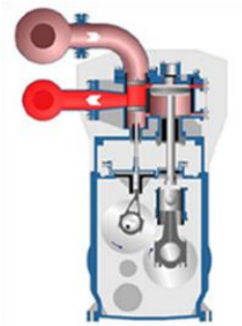

Piston compressor (pict. Spilling)



Screw compressor (pict. Kobelco)

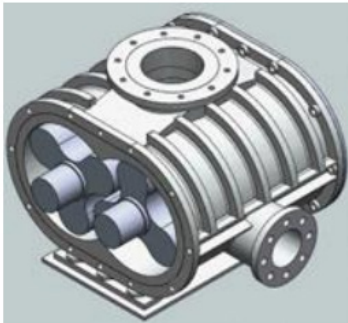

Roots (lobe) compressor

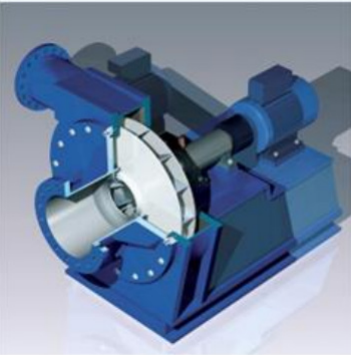

Turbo fan Faszination Energie

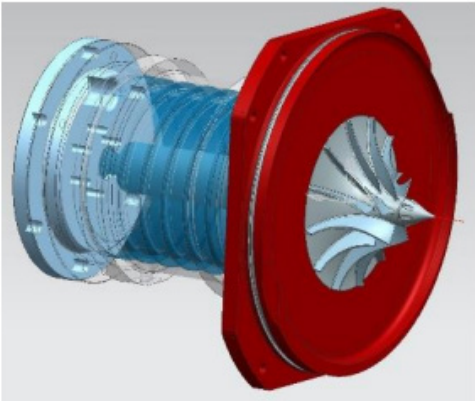

Direct drive turbo compressor (pict. CSTechom)

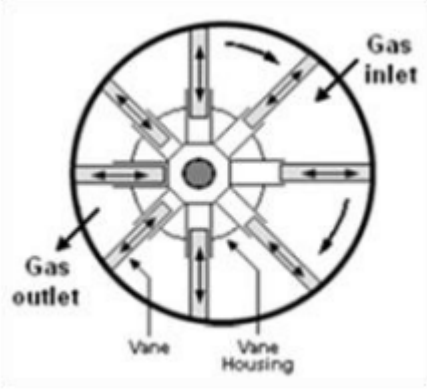

Rotary vane compressor 30. März 2026



Spindle compressor (pict. Hamburg Vacuum)



# Gründe für Industriewärmepumpe

- Finanziell
- Abhängigkeit von Öl/Gas verringern
- Grüne/ökologische Produkte
- Zu viel Abwärme
- Selbstgesteckte oder gesetzlich vorgegebene Klimaziele
- Trafostation des Stadtteils zu klein
- ...



# Was bleibt für uns Forscher zu tun?



# Angepasste Kältemittelgemische

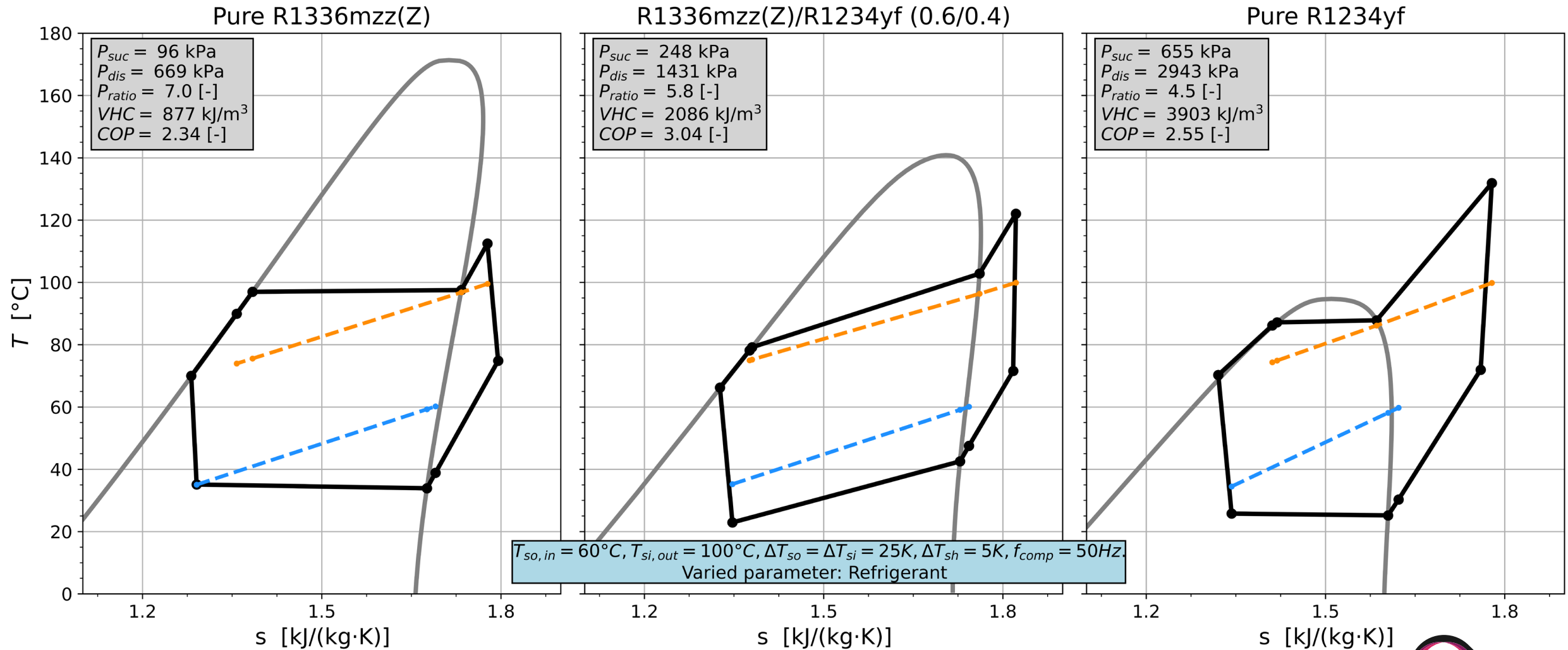

# Verdichterkorrelation für verschiedene Kältemittel

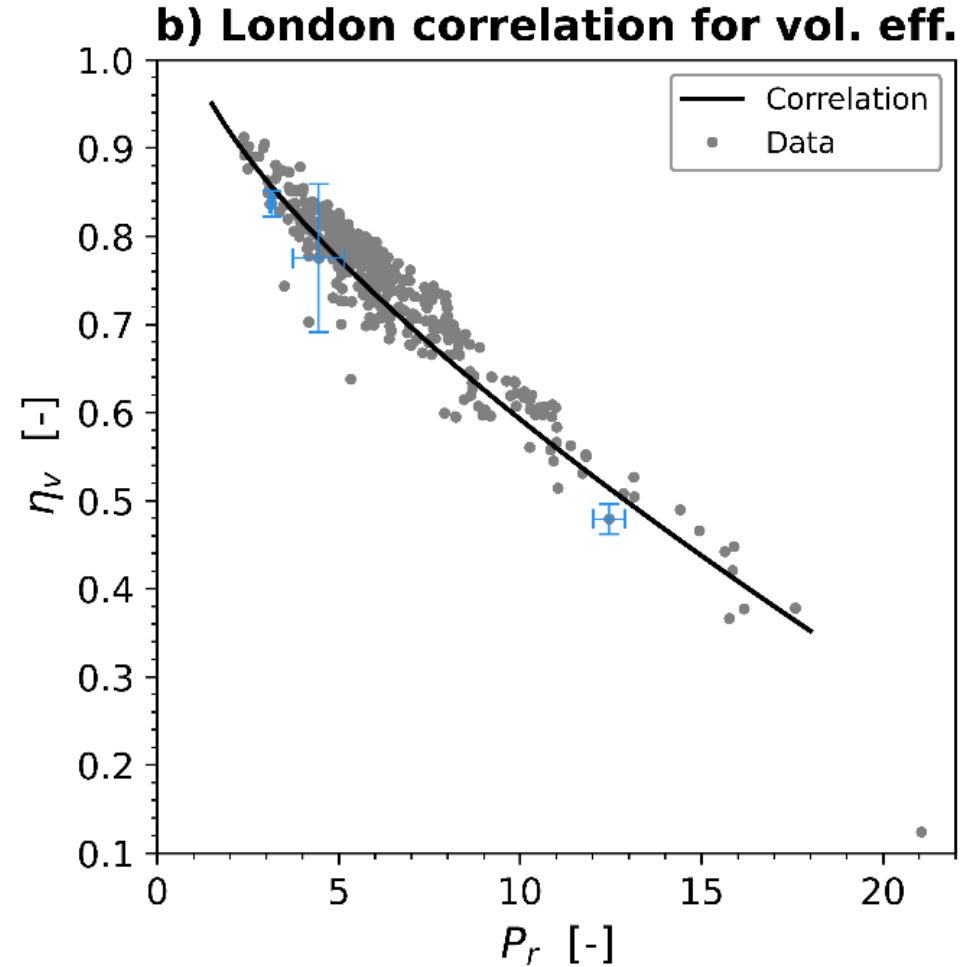
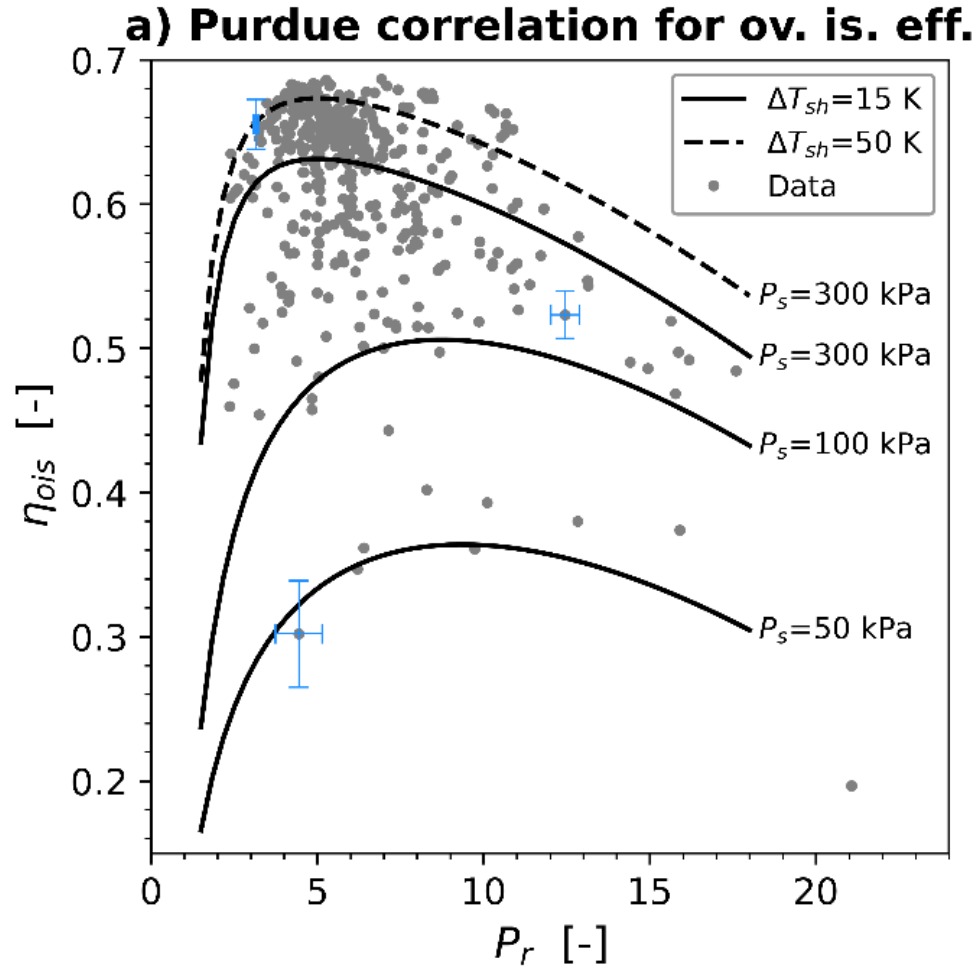

# Ölqualitätssensoren

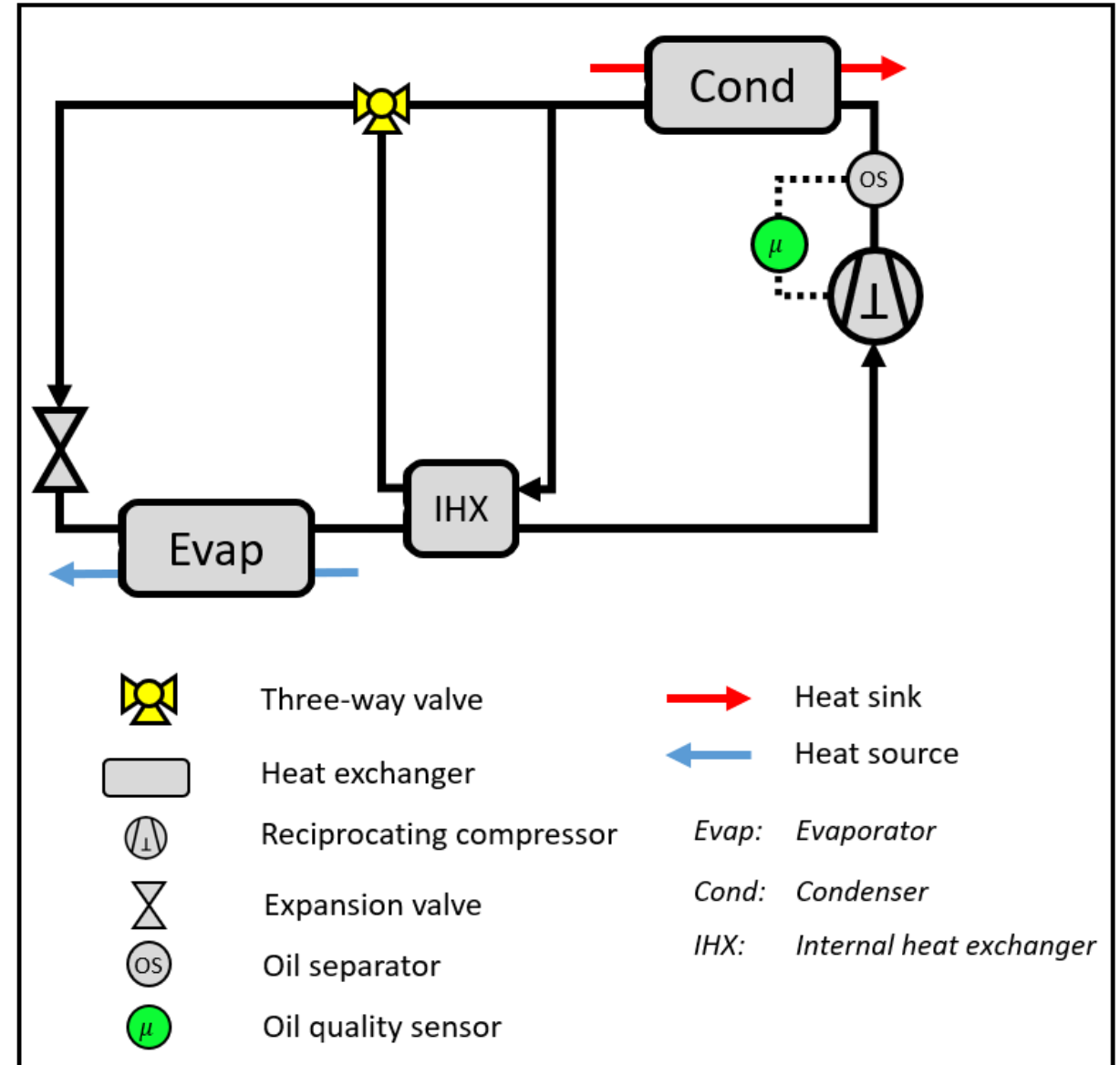
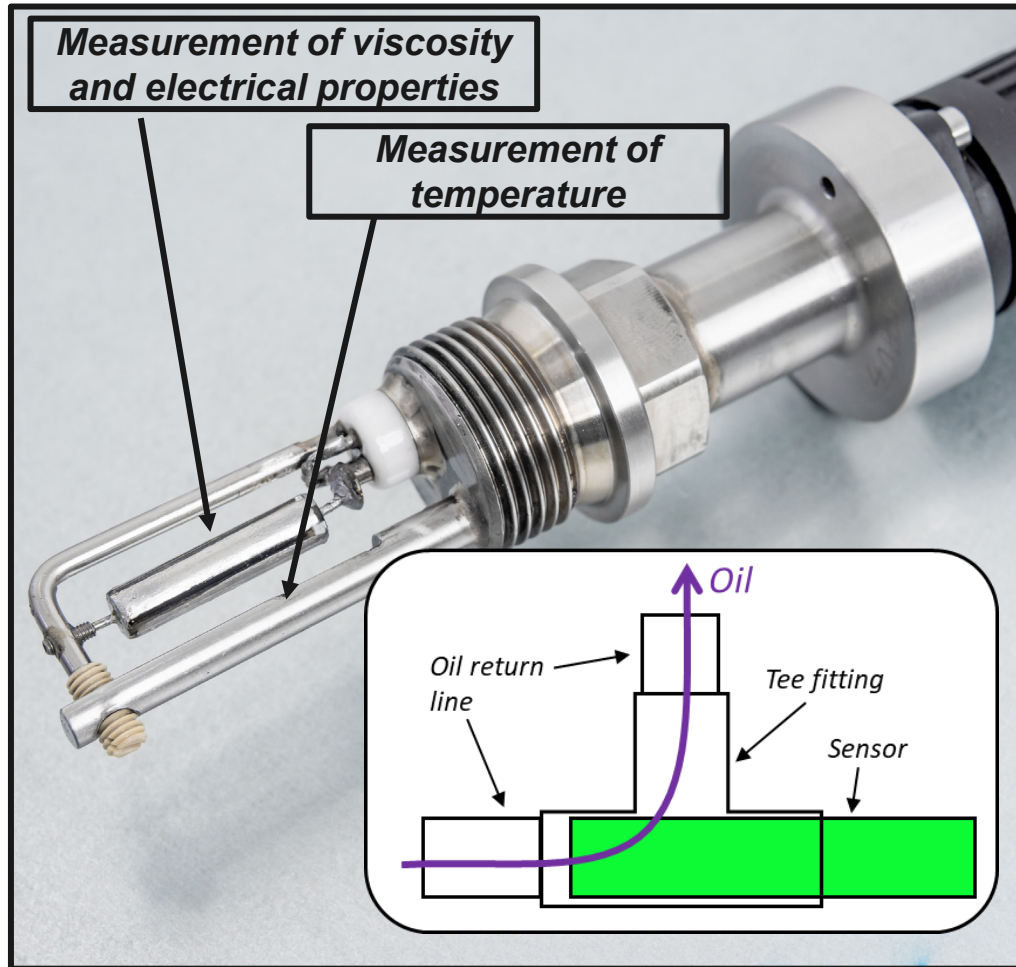

**Die Liste wäre zu lang für heute**

# Institut für Energiesysteme – Ostschweizer Fachhochschule



fördern: Faszination Energie



**OST**  
Ostschweizer  
Fachhochschule

**IES** | Institut für  
Energiesysteme

**Vielen Dank!**

**Leon Brendel PhD**

**Dr. Cordin Arpagaus**

**Frederic Bless, PhD**

**Prof. Daniel Gstöhl,**

**Prof. Stefan Bertsch**

**30. März 2026**